

P Item	CODICE Code	DESCRIZIONE Designation
1	ZA91191	Cartuccia completa Ø35mm APERTA
2	ZGHI010	Ghiera ferma cartuccia 37 x 1
3	ZCAP034..	Cappuccio sottoleva metallo 37x1
4	ZLEV084..	Leva Stick lunga
5	ZAER002..	Aeratore 24x1
6	ZBAS038..	Basetta con o-ring
7	ZFLX101..	Set flex inox SOFT PX DVGW M.10x1 F.3/8 cm.45 (2 pz)
8	ZFIS043	Set fissaggio
9	ZAST046..	Asta pomolo snodino Ø4mm piegata
10	ZSCA040..	Scarico 1"1/4 modello NEW (ZM) c/tappo host.

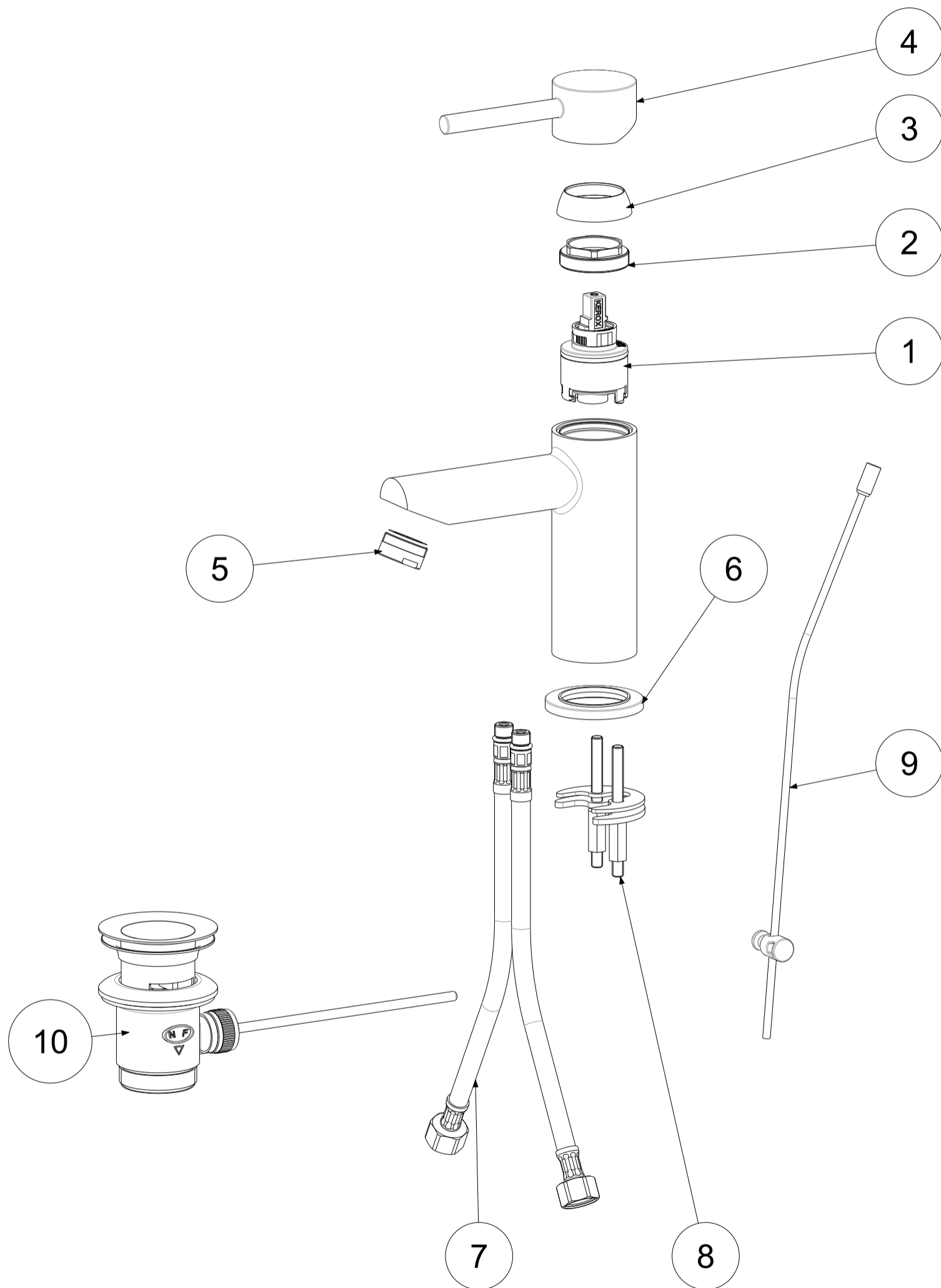

	APPROVATO: Approved:		A3	SCALA Scale	0,400	MATERIALE Material	VARIOUS
	DISEGNATO: Design:	Giampani	13/03/2019	UNITA' Unit	mm	SERIE Range	STICK
			DESCRIZIONE - Description: Miscelatore lavabo S/A 1"1/4(Cert. DVGW) Wash Basin mixer 1" 1/4 PUW (new with high spout)				
FOGLIO - Sheet:		Ricambi	CODICE - Part Number:		SK075HCR		