

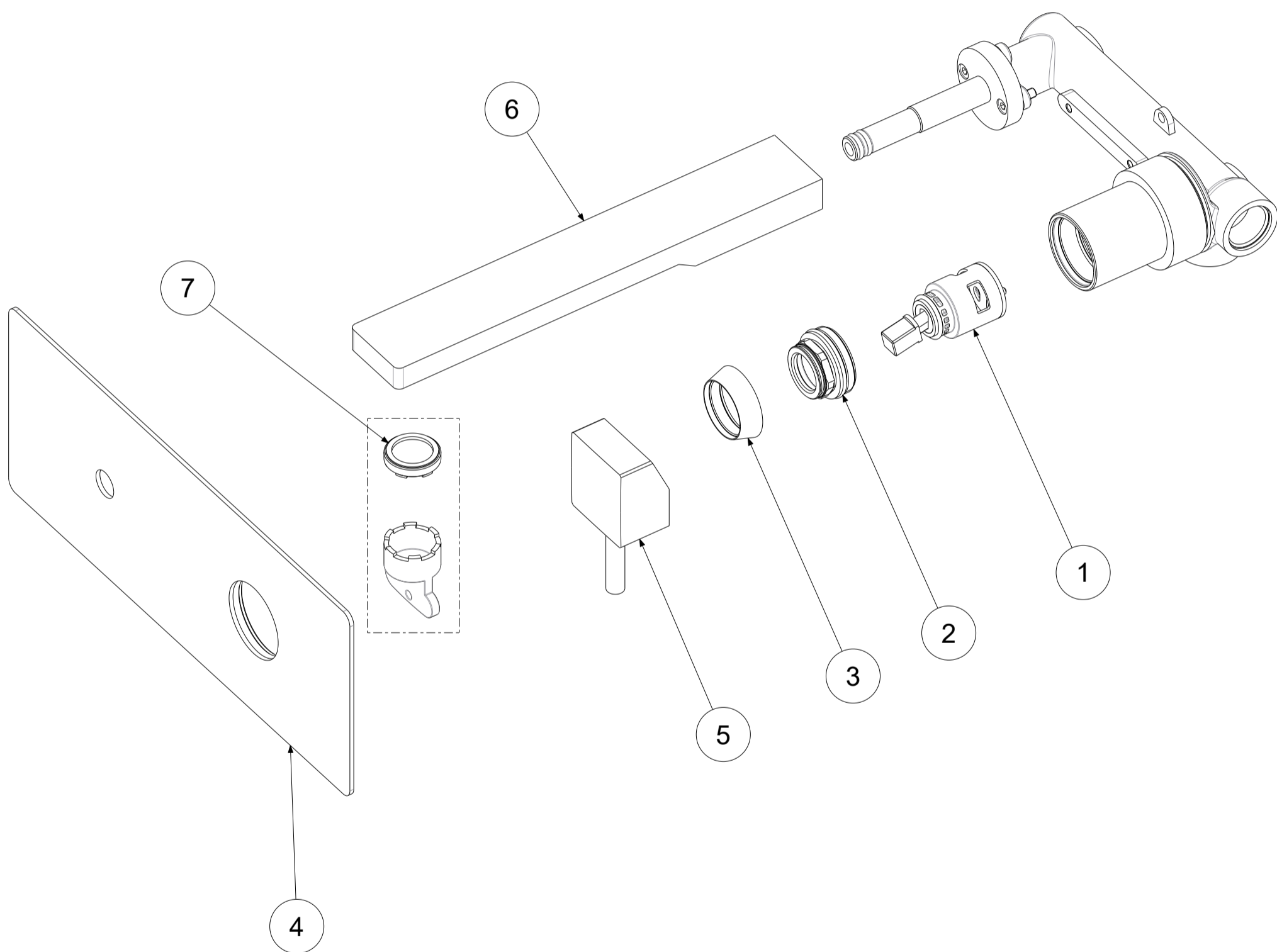

P Item	CODICE Code	DESCRIZIONE Designation
1	ZA91231	Cartuccia completa Ø25mm
2	ZGHI011..	Ghiera fermacartuccia (NUOVA) M30x1
3	ZCAP062..	Cappuccio sottoleva in metallo
4	ZPIA110..	Piastra in acciaio inox 2 fori con guarnizioni
5	ZLEV182..	Leva completa con perno corto mod.ASTA
6	ZBOC108..	Bocca con aeratore l.200mm
7	ZAER090	Aeratore M24x1 SLIM AIR con chiavetta

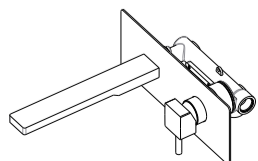

	APPROVATO: Approved:		A3	SCALA Scale	0,500	MATERIALE Material	VARI
	DISEGNATO: Design:	Gaboardi	30/07/2020	UNITA' Unit	mm	SERIE Range	LEVEL
		DESCRIZIONE - Description: Miscelatore incasso 2 Fori c/Piastra rettangolare e bocca mm.200 l.Asta					
FOGLIO - Sheet:		Ricambi		CODICE - Part Number:		LEA105CR	